

# NK CUSTOM BRICKS MICRO WARBIRDS P-51D MUSTANG "CRAZY HORSE"

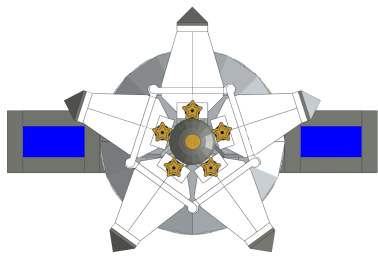

1

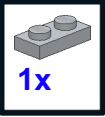

2

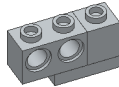
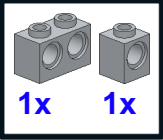

3

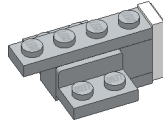
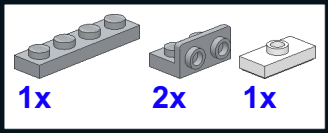

4

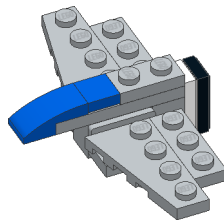
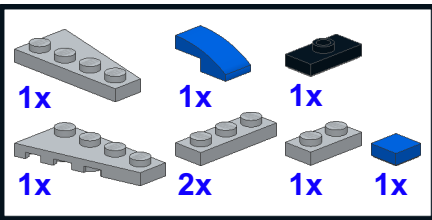

5

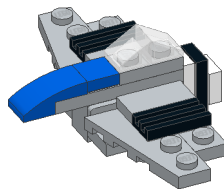
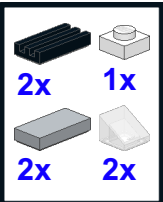

6

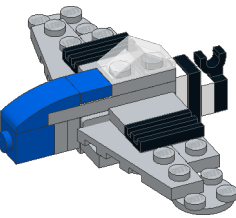
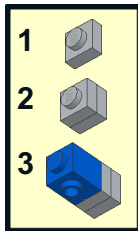
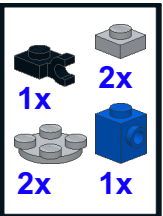

7

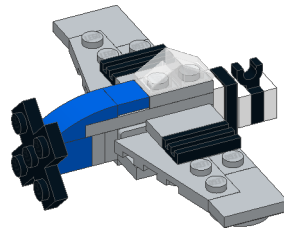
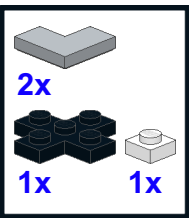

8

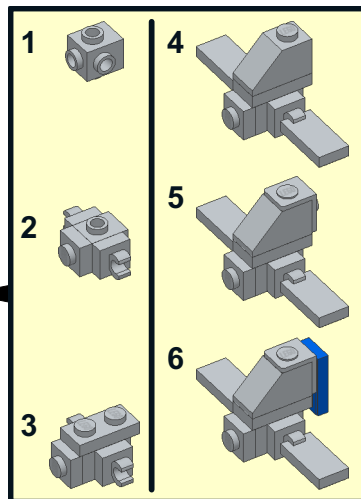
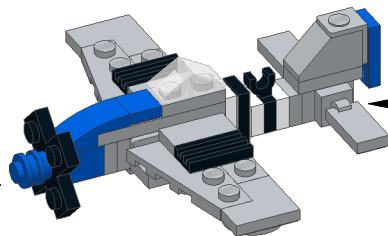
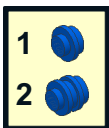
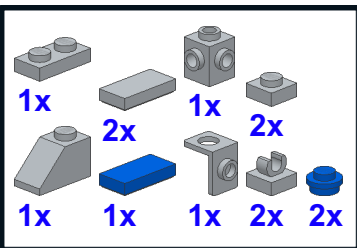

9

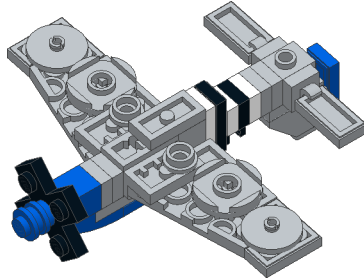
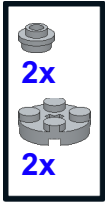

10

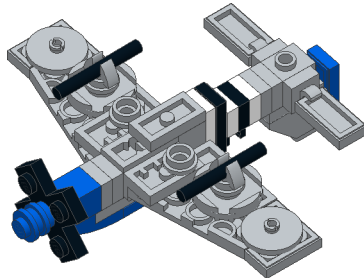
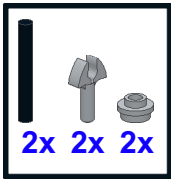

**SUBSTITUTE PART:**  
Replace 2 bar clips with  
2 Brickarms monopods

**SUBSTITUTE PART:**  
Replace 2 3L bars with  
2 Brickarms 20mm shell.

11

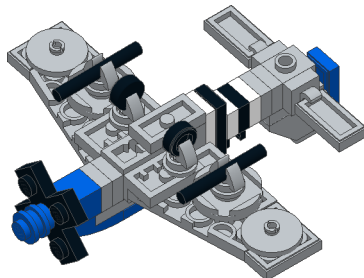

**SUBSTITUTE PART:**  
Replace 2 bar clips with  
2 Brickarms monopods

12

